



2500/F2500 Series Grade 1 Rim Device 2700/F2700 Series Grade 1 V/R Exit Device

25-Year Warranty

ANSI GRADE 1
ANSI/BHMA A156.3-2001
Type 1 & Type 2
Exceeds 500,000 Cycles



UL Listed for "A" Label Doors
Rated Up to 3 Hours
UL10C Positive Pressure Rated
Conforms to UBC 7-2 (1997)
UL305 Listed for Panic Hardware
UL10B Neutral Pressure Rated



Comply with ANSI117.1 for accessible and usable Buildings and Facilities Standards



2570 Strike

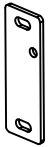

2571 Shim



2500 Rim Device
Aluminum



2572 Top Strike



2573 Standard Bottom Strike



2700 V/R Rim Device
US32D

SPECIFICATIONS

CERTIFICATIONS

- ANSI Grade 1 approved, exceeds 500,000 cycles.
- UL305 Listed for Panic Hardware.
- UL Listed for up to 3hrs on "A" label Fire Doors.
- UL10B Neutral Pressure rated.
- UL10C/UBC7-2(1997) Positive Pressure rated.
- Comply with ANSI117.1 for accessible and usable Buildings and Facilities Standards.

DOOR FITTING

- 1-3/4" thick standard.
- Rim – 4-1/2" min. stile width for Single Door and 5/8" stop.
- V/R – 4-1/2" minimum stile with trim.
3-1/2" minimum stile without trim.
- Mounting Height – 41" from CL to finished floor.

DOOR WIDTH

- 36", rail can be cut from the end to fit door size down to 30".
- 48", rail can be cut from the end to fit door size down to 40".

DOOR HEIGHT

- 84" (7') - Standard with 36" Door width.
- 96" (8') - Standard with 48" Door width.
- 1' long Extension Rod available. (ETR12)

STRUCTURE

- Head Cover – Plated Zinc Alloy.
- Chassis – Steel or Stainless Steel.
- End Cap – Plated Zinc Alloy.
- Rail Assembly – Heavy Gauge Steel or Stainless Steel.

LATCH BOLT

- Rim – Stainless Steel, 3/4" throw.
- V/R – Top: Stainless Steel, 19/32" throw.
Bottom: Stainless Steel, 21/32" throw.

Mount with Outside Trim

Standard Backset 2-3/4" Stop 5/8"

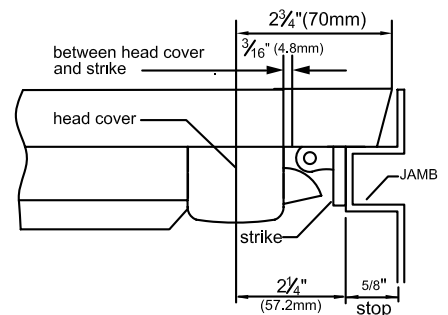

2500/F2500 Series Grade 1 Rim Device 2700/F2700 Series Grade 1 V/R Exit Device



SPECIFICATIONS

STRIKE

- Rim – Solid Stainless Steel (2570). 1/8" Thick Steel Shim (2571) included for 1/2" Door Stop.
- V/R – Top: Stainless Steel with roller. (2572)
Bottom: Stainless Steel with roller. (2573) Alternative Bottom Strike – 2574 & 2575.
- Overlapping Strike (2285) for use on Rim Device with Surface Vertical Rod.



FASTENERS

- Furnished with wood & Machine screw.
- Thru-Bolts for F2500/F2700. (1345/1349)



FINISH

- Aluminum, Duro, and US32D.

HANDING

- Rim – Reversible non-handed.
- V/R – Standard with RHR or LHR, easily field reversible.

DOGGING

- Standard for 2500/2700 only, Cylinder Dogging optional (with Dogging Kit – 2CD36 or 2CD48).

ALARM

- Alarm Kit available, Item code – 2AK36 or 2AK48.

DIMENSIONS

Projection: 2-5/8" maximum, 1-27/32" dogged.

Overall Size: 5-3/32" Height x Width 32-34/64" or 44-34/64".

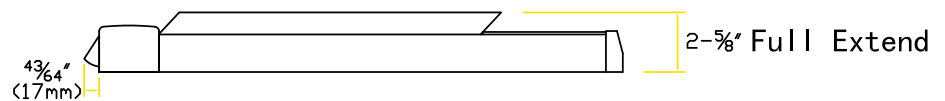
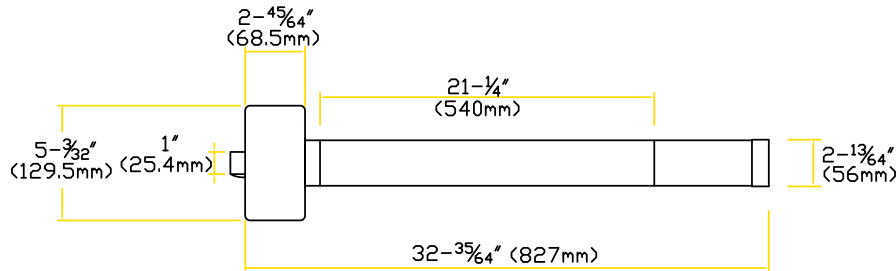

Projection: 2-5/8" maximum.

Overall Size: 5-3/32" Height x Width 32-35/64" or 44-35/64".

Top Latch Case: 4-23/32" Height x Width 1-37/64", Latch Bolt 19/32" throw.

Bottom Latch Case: 4-23/32" Height x Width 1-3/16", Latch Bolt 21/32" throw.

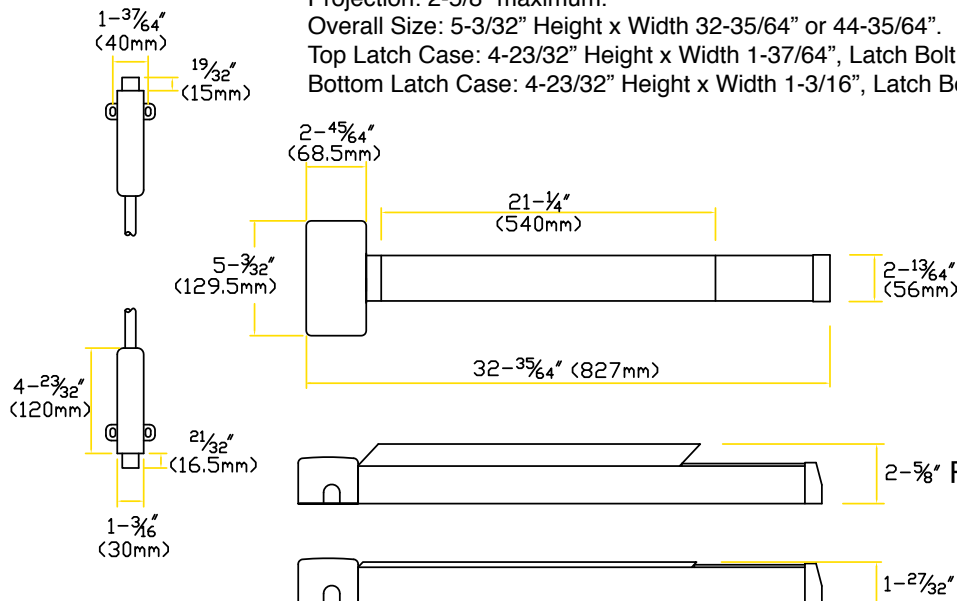









2500/F2500 Series Grade 1 Rim Device 2700/F2700 Series Grade 1 V/R Exit Device

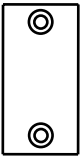

OUTSIDE TRIMS

<p>500L Lever Trim Finish: US26D, US10B Functions(ANSI): 500L Entrance(08) 501L Passage(14) 504L Night Latch(09) 515L Dummy(02)</p>  <p>Clutch</p>	<p>700ETL Escutcheon Lever Trim Finish: Aluminum, Duro, US26D Functions(ANSI): 700ETL Entrance(08) 701ETL Passage(14) 704ETL Night Latch(09) 715ETL Dummy(02)</p> 	<p>400TP Thumbpiece Trim Finish: Aluminum, Duro, US32D Functions(ANSI): 400TP Entrance(05) 401TP Passage(15) 404TP Night Latch(06) 415TP Dummy(02)</p> 	<p>611PT Pull Trim Finish: US10B, US32D Functions(ANSI): 611PT w/Cylinder(03) 615PT Dummy(02) 630PT Cover Plate</p> 	<p>611OP Outside Plate Trim Finish: Aluminum, Duro Functions(ANSI): 611OP w/Cylinder(03) 615OP Dummy(02) 630OP Cover Plate</p> 
--	--	---	--	---

STRIKES & FILLERS

<p>Surface Strike and Shim For 2500/F2500</p>  <p>2570 2571 Shim, 1/8" thick</p>	<p>V/R Top Strike For 2700/F2700</p>  <p>2572</p>	<p>V/R Bottom Strike For 2700/F2700</p>  <p>2573</p>	<p>Alternative Bottom Strike</p>  <p>2574 2575</p>
<p>Filler</p>  <p>9222 Latch front filler 1-1/8" x 2-1/4"</p>	<p>Filler</p>  <p>9209 ASA strike filler 1-1/4" x 4-7/8"</p>	 <p>2285</p>	<p>Overlapping Strike</p> <p>Used for double door on inactive door to receive latch on active door.</p>

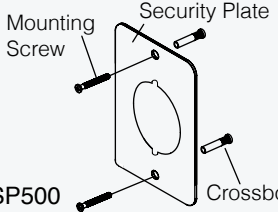
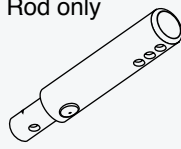
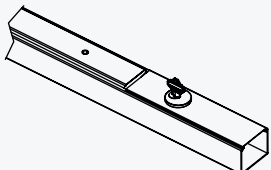
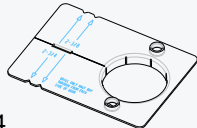
ACCESSORIES

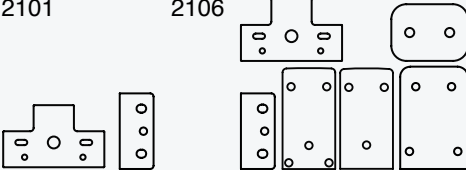
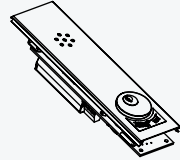
<p>Thru-Bolt For Door 1-3/4" ~ 2" 1345 – for 2500/F2500(5pcs) 1349 – for 2500/F2500(9pcs) For Door 2" ~ 2-1/4" 2145 – for 2700/F2700(5pcs) 2149 – for 2700/F2700(9pcs) Finish: US32</p> 	<p>Security Plate Use on 500L</p>  <p>SP500</p>	<p>Extension Rod ETR12 – 1' extension</p> <p>* For extend the Top Rod only</p> 	<p>Cylinder Dogging Kit</p>  <p>2CD36 – for Exit Device 36" 2CD48 – for Exit Device 48"</p>
<p>Thru-Bolt Jig For 500L Vertical Thru-Bolt Backset 2-3/4", CTC 2-3/4"</p>  <p>9234</p>	<p>Dogging Key</p>  <p>9201</p>	<p>Glass Bead Shim Kits For 2500/F2500 For 2700/F2700</p> <p>2101 2106</p> 	<p>Alarm Kit (with decal)</p>  <p>2AK36 – for door width 36" 2AK48 – for door width 48"</p>