



Philadelphia Hardware Group, Inc.

6590 Top Gun St.
 San Diego, CA 92121
 www.philhardware.com
 Tel: 858-642-0450
 Fax: 858-642-0454
 V091423

Advantage Door Closer 9000 Series

**COMMERCIAL
 GRADE 1**

ANSI GRADE 1

ANSI/BHMA A156.4

Series 2000, PT1

Exceeds 1,500,000 cycles with Backcheck



UL10C Positive Pressure Rated. Conforms to UBC 7-2 (1997). (Uniform Building Code Standard)



Comply with ANSI A117.1



Features

- Multi Size Spring
- Adjustable Power Size #1~6
- Factory Preset Size #3
- Standard With Adjustable Back Check
- Tri-Packed For All Types of Installation



Specifications

| | |
|-----------------|---|
| Material | Aluminum Alloy Body, Forged Steel Arm, Heat Treated Forged Steel Piston, Double Heat Treated Steel Pinion |
| Cover | Standard With Full Plastic Cover, Optional With Metal Cover |
| Valves | Staked Valve For Adjustments Triple Valve Control – Closing Speed, Latching Speed & Back Check |
| Arms & Brackets | Standard With Regular Arm and Parallel Bracket |
| Screws | Standard With Self Tapping Wood Screws, Machines Screws & Sex Bolts |
| Model | 9000 – Adjustable Power #1~6 With Back Check 9000DA – Adjustable Power #1~6 With Back Check & Delay Action |
| Finish | ALUM (689), DURO (695), GOLD (696), BLACK (693) |

Technical Dimensions

- A.) Length of Closer Body – 11-7/8"
- B.) Horizontal Mounting Holes – 11-1/8"
- C.) Vertical Mounting Holes – 9/16"
- D.) Height of Closer Body – 2"
- E.) Projection From Door – 2-7/8"

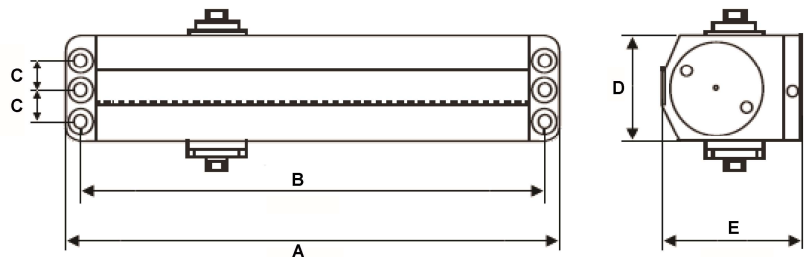

SAN DIEGO

CHICAGO

ATLANTA

DALLAS







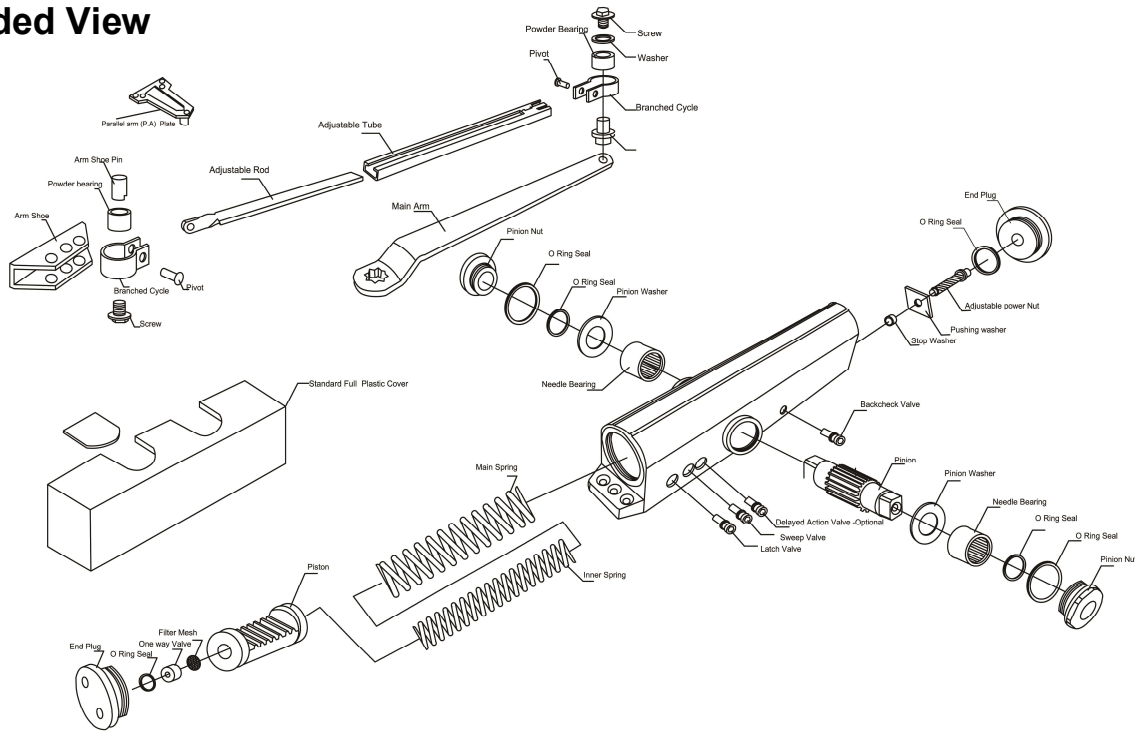

Philadelphia Hardware Group, Inc.

6590 Top Gun St.
 San Diego, CA 92121
 www.philhardware.com
 Tel: 858-642-0450
 Fax: 858-642-0454
 V091423

Exploded View

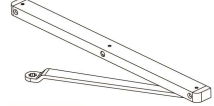

Accessories

| | | | | |
|--|---|---|---|---|
| 9001HO Hold Open Arm  | 9002C Parallel Rigid Cush Arm  | 9002SC Parallel Rigid Spring Cush Arm  | 9003HOC Parallel Rigid Hold Open Cush Arm  | 9003HOSC Parallel Rigid Hold Open Spring Cush Arm  |
| 9004EF Extended Forearm  | 9005A Parallel Rigid Arm  | 9006TA Slide Track Arm With Hold Open  | HF01 Flat Wrench For Hold Open Arm  | PAB01 Parallel Bracket  |
| BSS02 Blade Stop Spacer  | 1344 Sex Bolts  | 90CO Full Cover  | 90DPPA Drop Plate – Parallel  | |

SAN DIEGO

CHICAGO

ATLANTA

DALLAS